

Please note that the data given here has been taken from the online catalog. For comprehensive information and data, please refer to the user documentation at <http://www.download.phoenixcontact.com>. The General Terms and Conditions of Use apply to Internet downloads.

## ► Extract from the online catalog

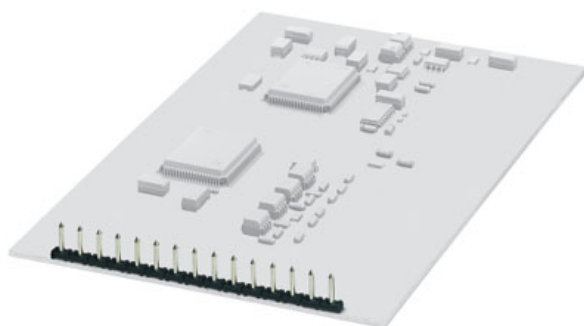

Male connector, 5.0 mm pitch, for use with compact printed circuit terminal CPT 1/...-ST-5.0, color: Black

The illustration shows a 15-position version

Order No.	1933257
Ord designation	PST 1,3/ 9-5,0
EAN	4017918918743
Pack	50 Pcs.
Customs tariff	85369010
Catalog page information	Page 312 (CC-2005)

## ► Technical data

### Dimensions / positions

Pitch	5 mm
Dimension a	40 mm
Number of positions	9
Pin dimensions	1,3 mm
Hole diameter	1.5 mm

### Technical data

Insulating material group	IIIa
Rated surge voltage (III/3)	4 kV
Rated surge voltage (III/2)	4 kV
Rated surge voltage (II/2)	4 kV
Rated voltage (III/2)	400 V
Rated voltage (II/2)	400 V
Maximum load current	10 A (Depends on the plug used)
Insulating material	PA
Inflammability class acc. to UL 94	V0

► Drawings

Drilling diagram

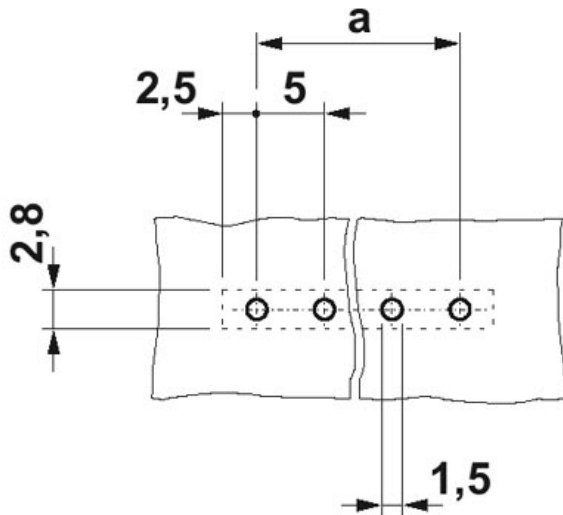

Dimensioned drawing

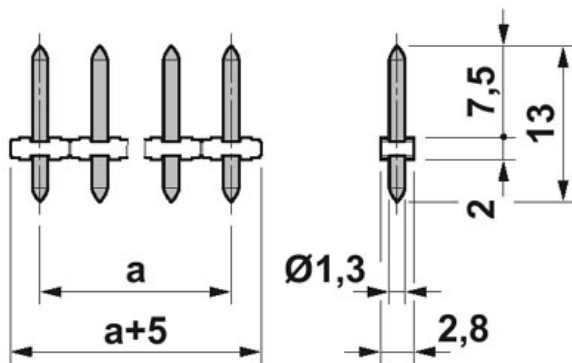

---

## ► Address

---

PHOENIX CONTACT Inc., USA  
586 Fulling Mill Road  
Middletown, PA 17057  
USA  
Phone (800) 888-7388  
Fax (717) 944-1625  
<http://www.phoenixcon.com>  
Phoenix Contact  
Technical modifications reserved;